

# ApenGroup



## PCH/new Series

High performance, total flexibility

**ApenGroup<sup>®</sup>**

# PCH/new Installation in Air Handling Unit

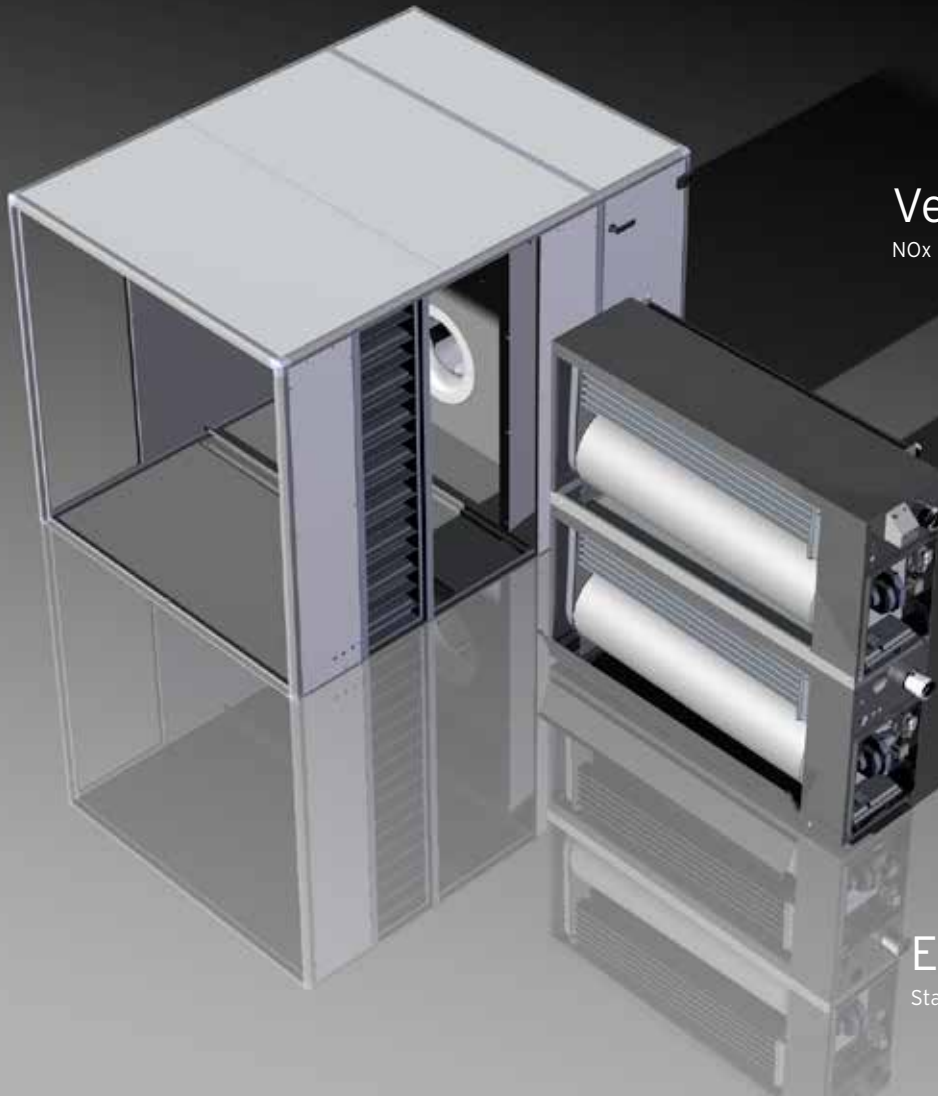

## Very Low Emissions

NOx lower than 30 ppm : Class 5

## Capacity Range

14 models from 5 kW to 400kW

## Automatic Control

Electronic ignition and  
simple electrical connection

## Fine Tuning

Standard power level managed by  
0 - 10 volt control input from air handling unit

## Extended Modulation

Standard continuous modulation from 100% to 20%

Condensing  
Product

# PCH/new

## Condensing Gas Heating Modules for Air Handling Units and Rooftops

New Gas Modules PCH/new present an extended power range which goes from 5 kW to 400 kW.

This result is achieved thanks to the possibility to assemble standard modules in parallel configuration.

You can choose between three gas module configurations:

### **A system:**

Single modules with max power between 5 kW to 100 kW.

### **B system:**

Combined modules with horizontal /vertical parallel combination with max power between 13 kW to 400 kW.

### **C system:**

Combined modules with horizontal parallel combination with max power between 13 kW to 200 kW.

This complete product range is able to satisfy all heating needs of your air handling units and Roof Top packaged systems.



PCH/new CAD rendering of Combustion Chamber and Heat Exchangers, premix burner and electronic board controls



## PCH/new: gas condensing energy modules

### EFFICIENCY UP TO 109%

Apen Group has designed and developed PCH/new heating modules for installation in air handling and roof-top units. PCH module is built with environment-friendly, totally recyclable materials, such as stainless steel and aluminium. The heat produced using PCH module's "clean combustion" is earth-friendly and convenient. A microprocessor-based device controls continuous modulation of thermal power output and adjusts it to heat requirements. When modulation of heat output is enabled, an advanced regulating device installed on the main burner monitors and adjusts flow rates of combustion air and gas.

### CLEAN COMBUSTION

PCH /new condensation modules are equipped with burners that fully premix air and gas. Moreover, a regulating device of heat output is installed. This results in:

- NO emissions of carbon monoxide (CO = 0);
- Very low emission of nitrogen oxides, below 30 parts per million (NOx < 30 ppm);
- Low emission of carbon dioxide, due to high combustion efficiency (109%) and to reduction of fuel consumption arising from heat output modulation.

### UNDIRECT HEAT EXCHANGE

The heat produced PCH is directly transferred to ambient air through undirect exchange with combustion products. These products flow inside a sealed system, totally separated from the air heated for environment. No intermediate fluid is required, so the hydraulic circuit is unnecessary and water freezing becomes an out-of-date issue. A few minutes are enough for the environment to warm up thanks to the absence of thermal inertia.

### NO NEED FOR A WATER BATTERY AND BOILER HEAT PLANT

- Savings on plant building cost (boiler, burner, pumps, safety and regulation devices, masonry work);
- Less space is required (units are smaller and require less clearance);
- No need for plant certification (our PCH module is already fully certified).

## HEAT EXCHANGER

Furnace and air/flue exchanger are entirely manufactured with stainless steel (with low carbon content) AISI 441 which assures maximum reliability and long life cycle.

The new cylinder shaped furnace and the air/flue exchangers, whose tube bundle is custom designed, guarantee performance that place PCH/new modules among the leading units for heat efficiency, with an outstanding value of 109%.

## PREMIX BURNER

The burner is entirely made of AISI 430 steel and undergoes specific engineering processing that guarantees top reliability and high thermal-mechanical performance.



## SAFETY AND CONTROL DEVICES

The following devices are installed on PCH modules:

1. Safety thermostat with manual reset and positive safety;
2. Electronic ignition device for the burner and ionization flame control device;
3. Ignition and flame detection electrodes.

## ELECTRONIC CARD

The microprocessor-based electronic card regulates continuous modulation of heat output and controls both the electrical fan for air/gas mixing and the gas valve.

## AIR/GAS MIXING:

### GUARANTEED SAFETY

An advanced technique of air/gas mixing guarantees total safety. The gas valve delivers gas according to the air/gas ratio set at the premises. If combustion air fails, the gas valve shuts up. If combustion air decreases, the valve automatically reduces gas flow while maintaining optimal combustion parameters.

## CAD DRAWINGS

When ordering a PCH/new module, ask for its size drawings. We supply drawings in 3D CAD format to ease your assembling work of the PCH module into your installation!

## GAS DIRECTIVE CERTIFICATION

Technical features of PCH module have been thoroughly checked and tested, then they have been approved and certified by KIWA GASTEC, the respected and renowned Body for European Certification. By assigning to PCH module the approval number 0476CQ0451, KIWA GASTEC has certified that this modules comply with the following Directives:

- 2009/142/CE - Directory on appliances burning gaseous fuels.
- 2006/42/CE - Machinery Directive.
- 2006/95/CE - Low Voltage Directive.
- 2004/108/CE - Directive on Electromagnetic Compatibility.

Condensing  
Product



# PCH/new Technical Data (A system)

Model		PCH020	PCH034	PCH045	PCH065	PCH080	PCH105
Type of appliance		B23P - B53P - C13 - C43 - C53 - C63 - C83					
CE approval	PIN.	0476CQ0451					
NOx class	Val	5					
		min	max	min	max	min	max
Rated thermal input (hi)	kW	4,75	19,00	7,60	34,85	8,50	42,00
Rated thermal output	kW	4,97	18,18	8,13	33,56	8,97	40,45
Efficiency hi (p.C.I)	%	104,63	95,68	106,97	96,30	105,50	96,30
Efficiency hs (p.C.S)	%	94,26	86,20	93,37	86,76	95,07	86,76
Chimney loss - burner ON (hi)	%	0,4	4,3	0,6	3,7	0,5	3,7
Chimney loss - burner OFF (hi)	%	< 0,1		< 0,1		< 0,1	
Casing heat loss <sup>(1)</sup>		0%		0%		0%	
Max. Condensation produced (2)	l/h	0,4		0,9		1,1	
Carbon monoxide CO (0% di O <sub>2</sub> ) (3)	ppm	< 5		< 5		< 5	
Nitrogen oxides - NOx - (0% di O <sub>2</sub> ) (4)		38 mg/kWh 22 ppm		42 mg/kWh 24 ppm		33 mg/kWh 19 ppm	
Available flue pressure	Pa	80		90		100	
Power supply	V	230 Vac - 50 Hz monophase					
Power absorbed	W	12	45	11	74	15	65
Power absorbed in stand by	W	< 5					
IP protection	IP	IP X5D					
Working temperature	°C	From -15°C to +40°C - (for lower temperatures order heating burner box electrical resistance kit)					
Ø Gas connection	GAS	UNI/ISO 228/1- G 3/4"		UNI/ISO 228/1- G 3/4"		UNI/ISO 228/1- G 3/4"	
Ø of air inlet/exhaust pipes	mm	80/80		80/80		80/80	
Minimum air flow (5)	m <sup>3</sup> /h	1.900		3.500		4.200	
Max applicable pressure	Pa	1.200		1.200		1.200	
Net weight	kg	39		48		58	

## NOTE:

(1) The casing heat losses are the same as those of the machine which contains the PCH.

(2) Max. Condensation produced value obtained by test at 30% Nominal load (Qn).

(3) Value reference with gas cat. H (G20).

(4) Value (statistical medium calculation) EN1020 reference gas cat. H (G20), based on Net calorific value (Hi).

(5) Minimum air flow has been calculated for a Δt value of 28°C. For process plants or special applications, with Δt value > 28°C, please contact Apen Group.



# PCH/new Dimensions (A system)

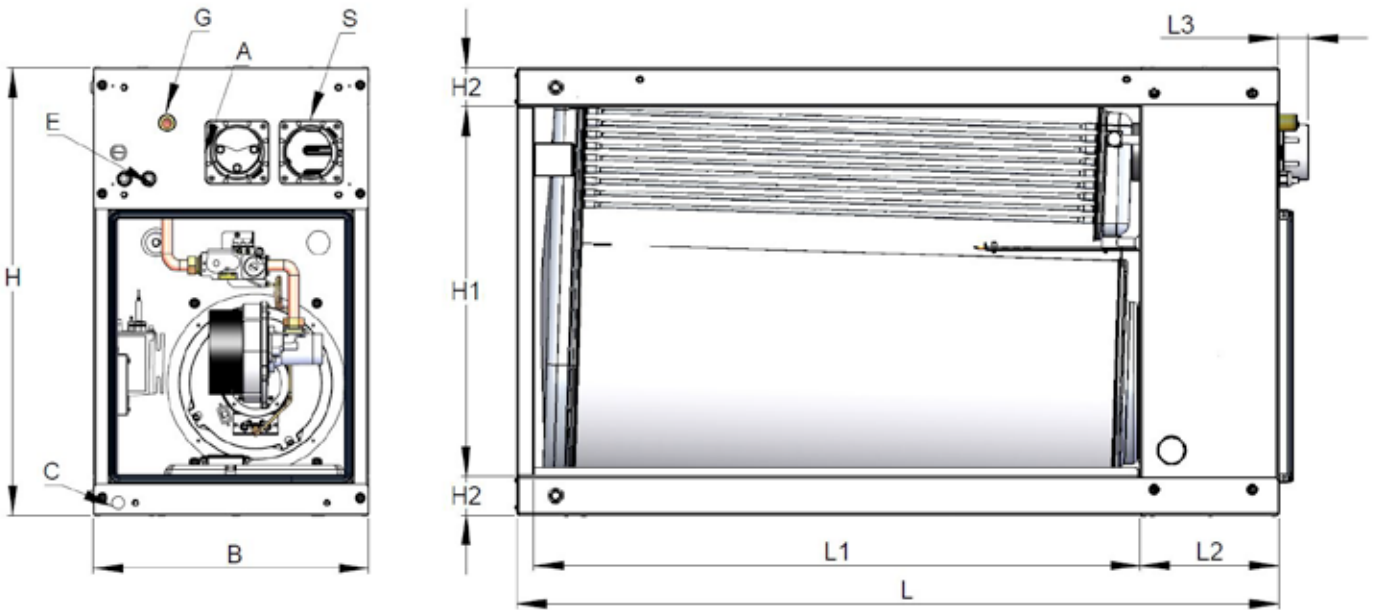

Dimensions (mm)

Model	B	H	L	H1	H2	H3	L1	L2	L3	E	G	A	S	C
PCH020	450	660	710	534	63	-	450	230	47	2X Ø21	3/4" GAS	Ø 80	Ø 80	1/2" GAS
PCH034			950				690							
PCH045		730	604	990										
PCH065			1.250	1.180										
PCH080			1.440	1.410										
PCH105		815	1.670											

# PCH/new Technical Data (B system)

Model		PCH130	PCH160	PCH210	PCH320	PCH420					
Type of appliance		B23P - B53P - C13 - C43 - C53 - C63 - C83									
CE approval	PIN.	0476CQ0451									
NOx class	Val	5									
		min	max	min	max	min	max	min	max	min	max
Rated thermal input (hi)	kW	12,40	130,00	16,40	164,00	21,00	200,00	21,00	300,00	21,00	400,00
Rated thermal output	kW	13,40	125,86	17,77	160,06	22,77	194,30	22,77	291,45	22,77	388,60
Efficiency hi (p.C.I)	%	108,06	96,82	108,35	97,60	108,40	97,15	108,40	97,15	108,40	97,15
Efficiency hs (p.C.S)	%	97,36	87,22	97,62	87,93	97,68	87,52	97,68	87,52	97,68	87,52
Chimney loss - burner ON (hi)	%	0,2	3,2	0,3	2,4	0,2	2,8	0,2	2,8	0,2	2,8
Chimney loss - burner OFF (hi)	%	< 0,1		< 0,1		< 0,1		< 0,1		< 0,1	
Casing heat loss <sup>(1)</sup>		0%		0%		0%		0%		0%	
Max. Condensation produced (2)	l/h	4,2		6,6		5,4		8,1		10,8	
Carbon monoxide CO (0% di O <sub>2</sub> ) (3)	ppm	< 5		< 5		< 5		< 5		< 5	
Nitrogen oxides - NOx - (0% di O <sub>2</sub> ) (4)		39 mg/kWh 22 ppm		32 mg/kWh 18 ppm		41 mg/kWh 23 ppm		41 mg/kWh 23 ppm		41 mg/kWh 23 ppm	
Available flue pressure	Pa	120		120		120		120		120	
Power supply	V	230 Vac - 50 Hz monophase									
Power absorbed	W	30	194	80	246	40	260	60	390	80	520
Power absorbed in stand by	W	< 5									
IP protection	IP	IP X5D									
Working temperature	°C	From -15°C to +40°C - (for lower temperatures order heating burner box electrical resistance kit)									
Ø Gas connection	GAS	UNI/ISO 228/1- G 1½"		UNI/ISO 228/1- G 1½"		UNI/ISO 228/1- G 1½"		UNI/ISO 228/1- 1 x G 1½" + 1 x G ¾"		UNI/ISO 228/1- 2 x G 1½"	
Ø of air inlet/exhaust pipes	mm	2 x 80/80		2 x 80/80		2 x 80/80		3 x 80/80		4 x 80/80	
Minimum air flow (5)	m³/h	13.000		16.400		20.000		30.000		40.000	
Max applicable pressure	Pa	1.200		1.200		1.200		1.200		1.200	
Net weight	kg	154		206		250		375		500	

## NOTE:

- (1) The casing heat losses are the same as those of the machine which contains the PCH.
- (2) Max. Condensation produced value obtained by test at 30% Nominal load (Qn).
- (3) Value reference with gas cat. H (G20).
- (4) Value (statistical medium calculation) EN1020 reference gas cat. H (G20), based on Net calorific value (Hi).
- (5) Minimum air flow has been calculated for a Δt value of 28°C. For process plants or special applications, with Δt value > 28°C, please contact Apen Group.

PCH 130/160/210



PCH 320



PCH 420





# PCH/new Dimensions (B system)

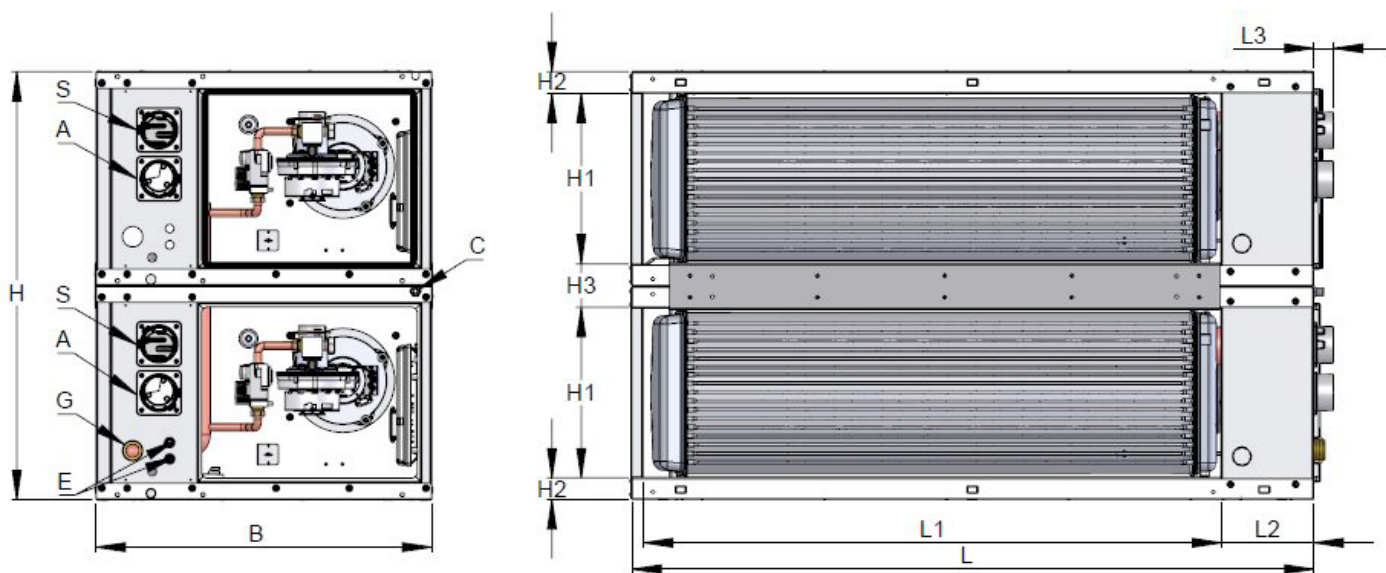

Dimensions (mm)

Model	B	H	L	H1	H2	H3	L1	L2	L3	E	G	A	S	C
PCH130	740	1.050	1.260	418	53	108	1.000	230	47	2X Ø21	G 1½"	2X Ø 80	2X Ø 80	1X ½" GAS
PCH160	1.450		1.190											
PCH210	825	1.680	1.575				1xG 1½" + 1xG ¾"				3X Ø 80	3X Ø 80		
PCH320			2.100				2xG 1½"				4X Ø 80	4X Ø 80		
PCH420														

# PCH/new Technical Data (C system)

Model		PCH132		PCH162		PCH212	
Type of appliance		B23P - B53P - C13 - C43 - C53 - C63 - C83					
CE approval	PIN.	0476CQ0451					
NOx class	Val	5					
		min	max	min	max	min	max
Rated thermal input (hi)	kW	12,40	130,00	16,40	164,00	21,00	200,00
Rated thermal output	kW	13,40	125,86	17,77	160,06	22,77	194,30
Efficiency hi (p.C.I)	%	108,06	96,82	108,35	97,60	108,40	97,15
Efficiency hs (p.C.S)	%	97,36	87,22	97,62	87,93	97,68	87,52
Chimney loss - burner ON (hi)	%	0,2	3,2	0,3	2,4	0,2	2,8
Chimney loss - burner OFF (hi)	%	< 0,1		< 0,1		< 0,1	
Casing heat loss <sup>(1)</sup>		0%		0%		0%	
Max. Condensation produced (2)	l/h	4,2		6,6		5,4	
Carbon monoxide CO (0% di O <sub>2</sub> ) (3)	ppm	< 5		< 5		< 5	
Nitrogen oxides - NOx - (0% di O <sub>2</sub> ) (4)		39 mg/kWh 22 ppm		32 mg/kWh 18 ppm		41 mg/kWh 23 ppm	
Available flue pressure	Pa	120		120		120	
Power supply	V	230 Vac - 50 Hz monophas					
Power absorbed	W	30	194	80	246	40	260
Power absorbed in stand by	W	< 5					
IP protection	IP	IP X5D					
Working temperature	°C	From -15°C to +40°C - (for lower temperatures order heating burner box electrical resistance kit)					
Ø Gas connection	GAS	UNI/ISO 228/1- G 1½"		UNI/ISO 228/1- G 1½"		UNI/ISO 228/1- G 1½"	
Ø of air inlet/exhaust pipes	mm	2 x 80/80		2 x 80/80		2 x 80/80	
Minimum air flow (5)	m <sup>3</sup> /h	13.000		16.400		20.000	
Max applicable pressure	Pa	1.200		1.200		1.200	
Net weight	kg	148		200		240	

## NOTE:

(1) The casing heat losses are the same as those of the machine which contains the PCH.

(2) Max. Condensation produced value obtained by test at 30% Nominal load (Qn).

(3) Value reference with gas cat. H (G20).

(4) Value (statistical medium calculation) EN1020 reference gas cat. H (G20), based on Net calorific value (Hi).

(5) Minimum air flow has been calculated for a Δt value of 28°C. For process plants or special applications, with Δt value > 28°C, please contact Apen Group.



# PCH/new Dimensions (C system)

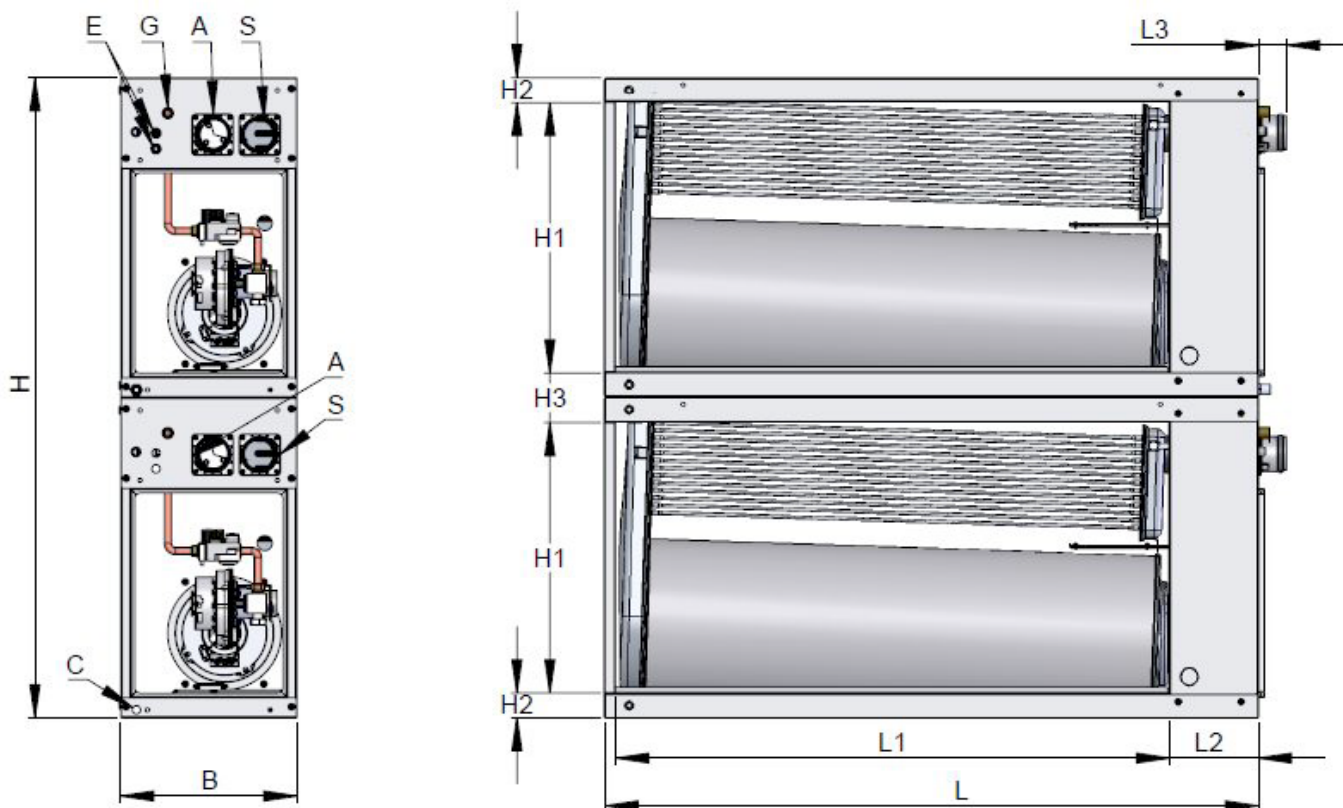

Dimensions (mm)

Model	B	H	L	H1	H2	H3	L1	L2	L3	E	G	A	S	C
PCH132	450	1.460	1.250	604	63	126	990	230	47	2X Ø21	1½" GAS	2X Ø 80	2X Ø 80	1X ½" GAS
PCH162		1.630	1.440	689			1.180							
PCH212		1.670	1.410											

# PCH/new Air flow rate- Pressure drop chart

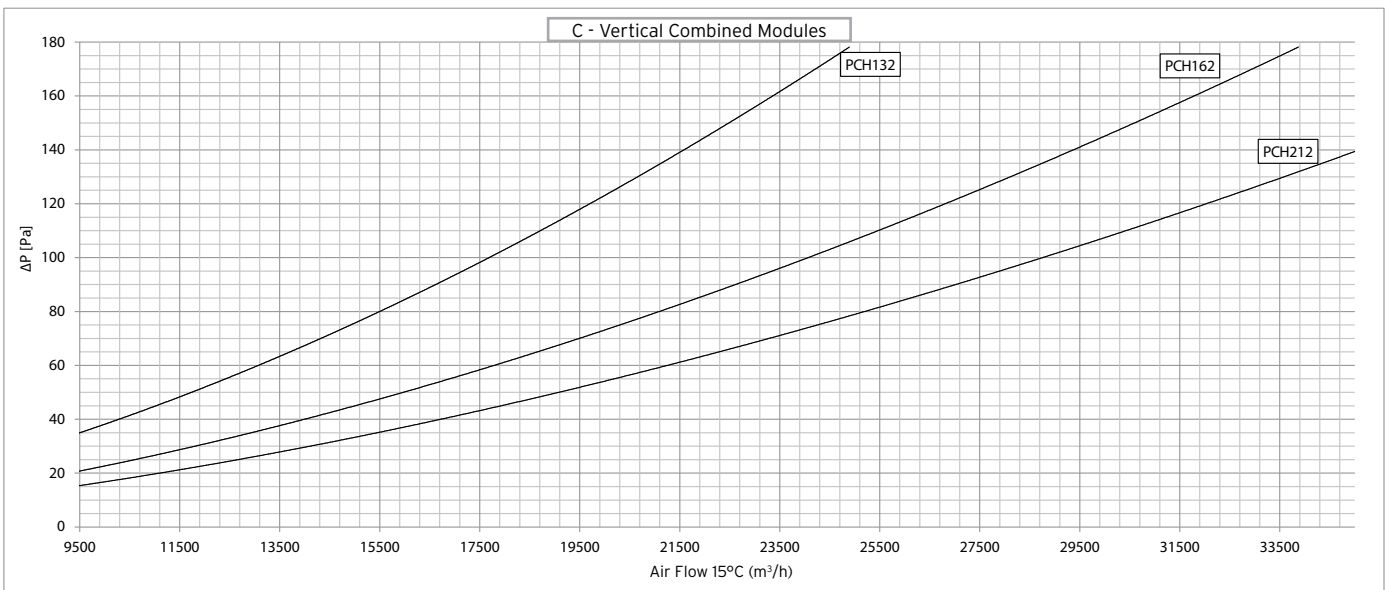
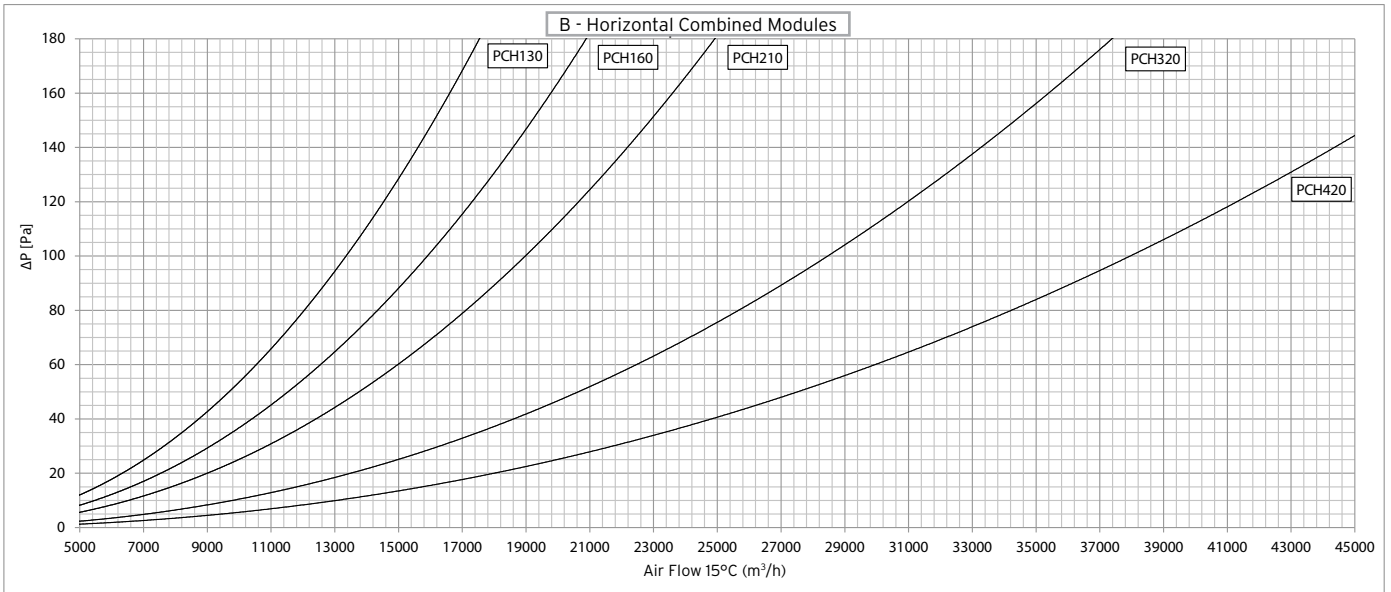
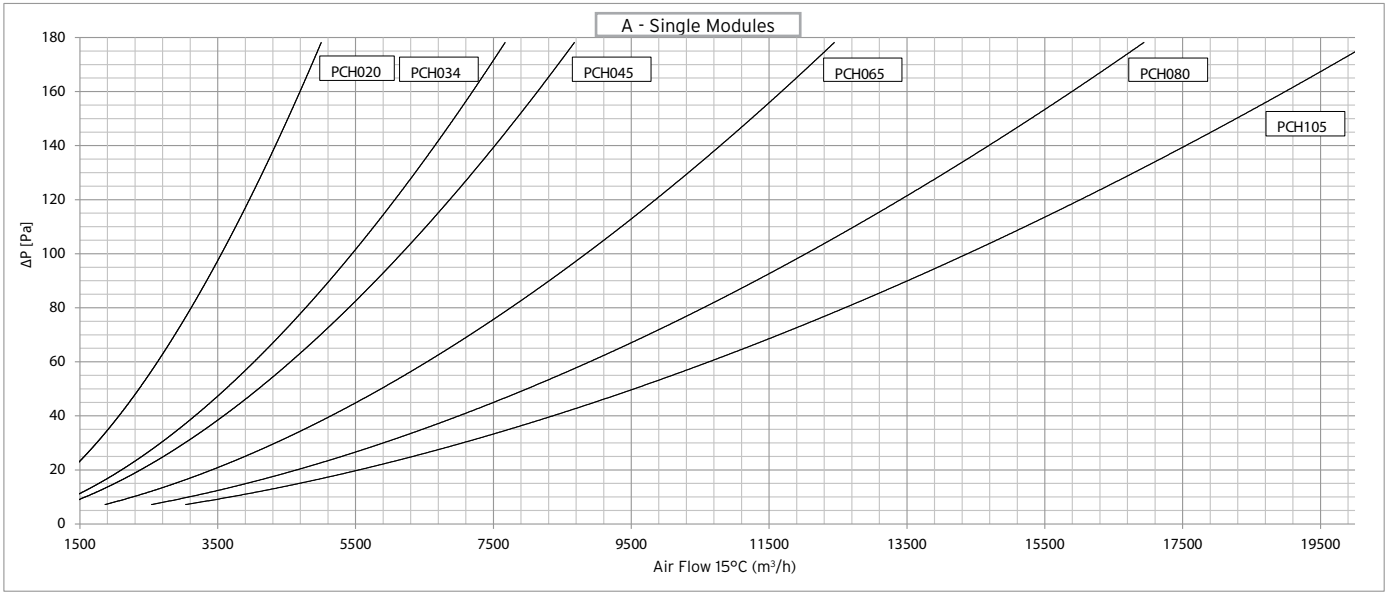

# PCH/new Air flow rate-Throughput speed chart

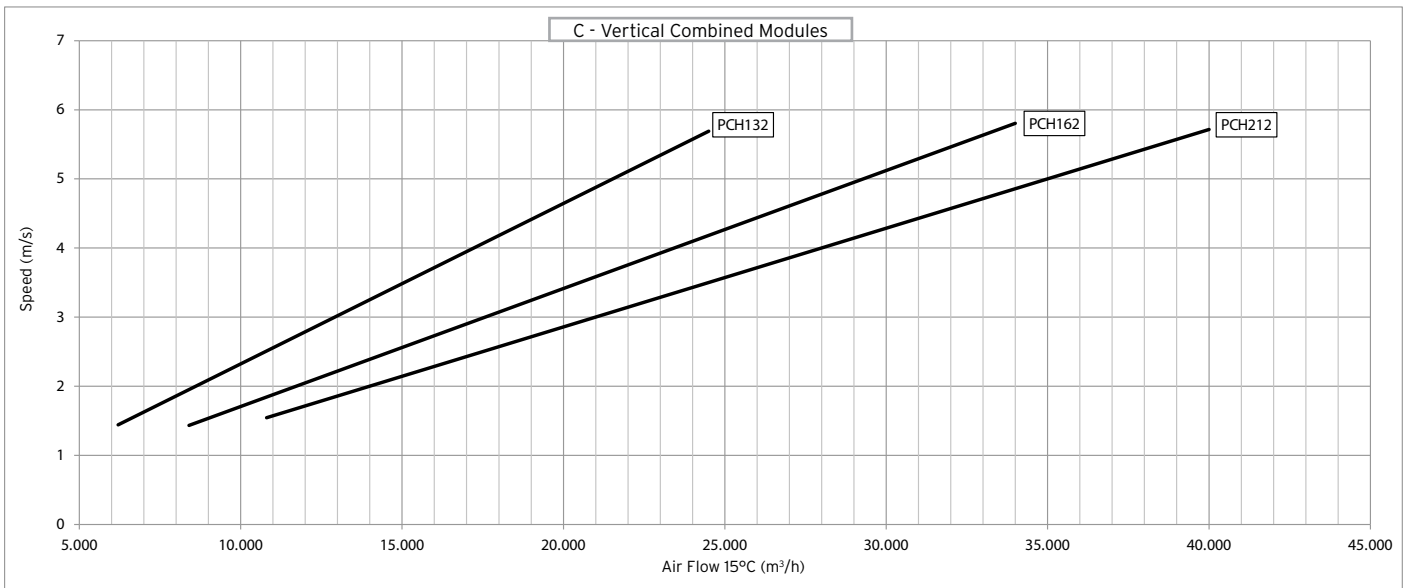
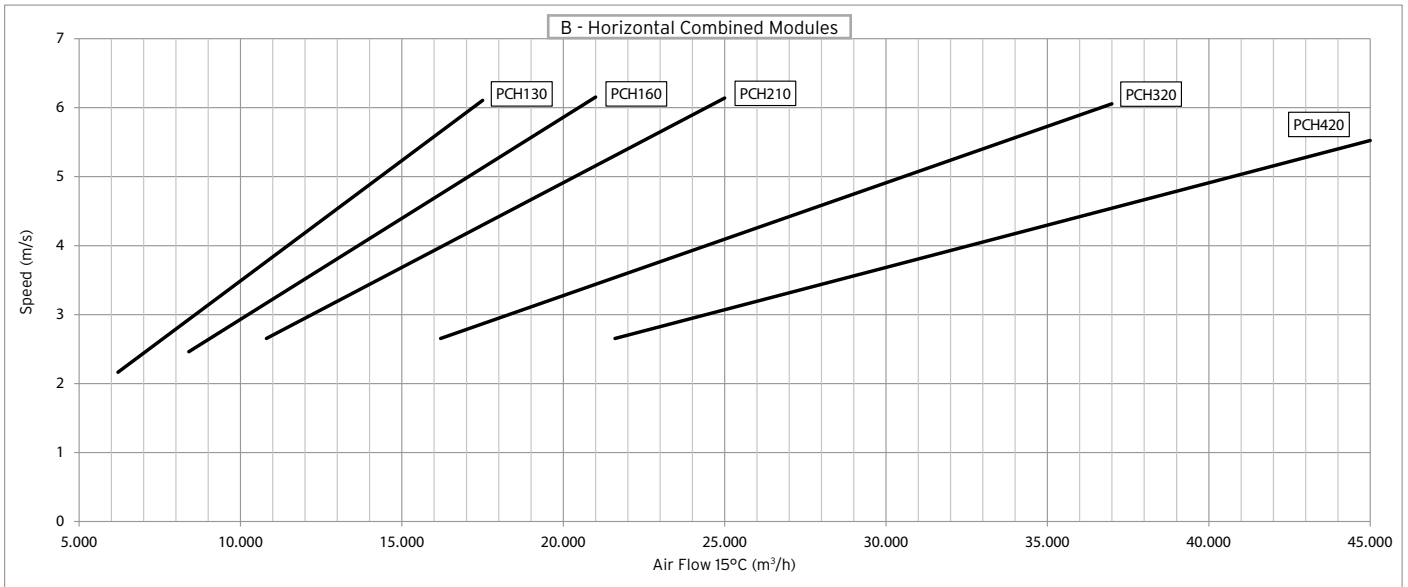
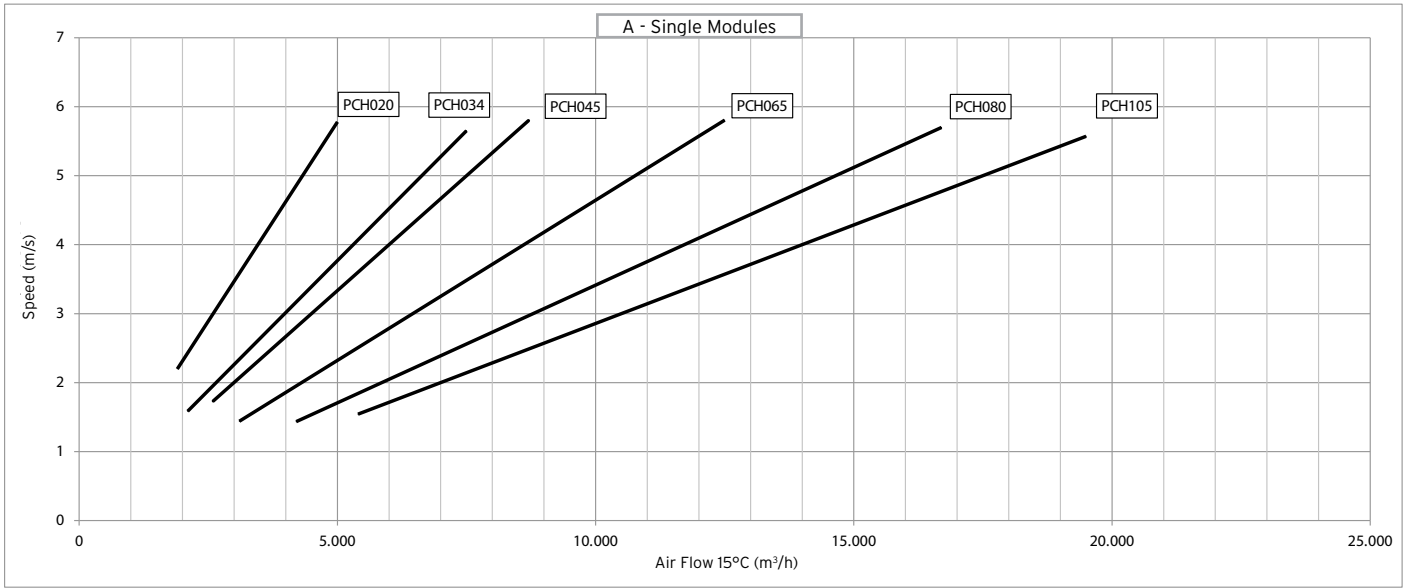



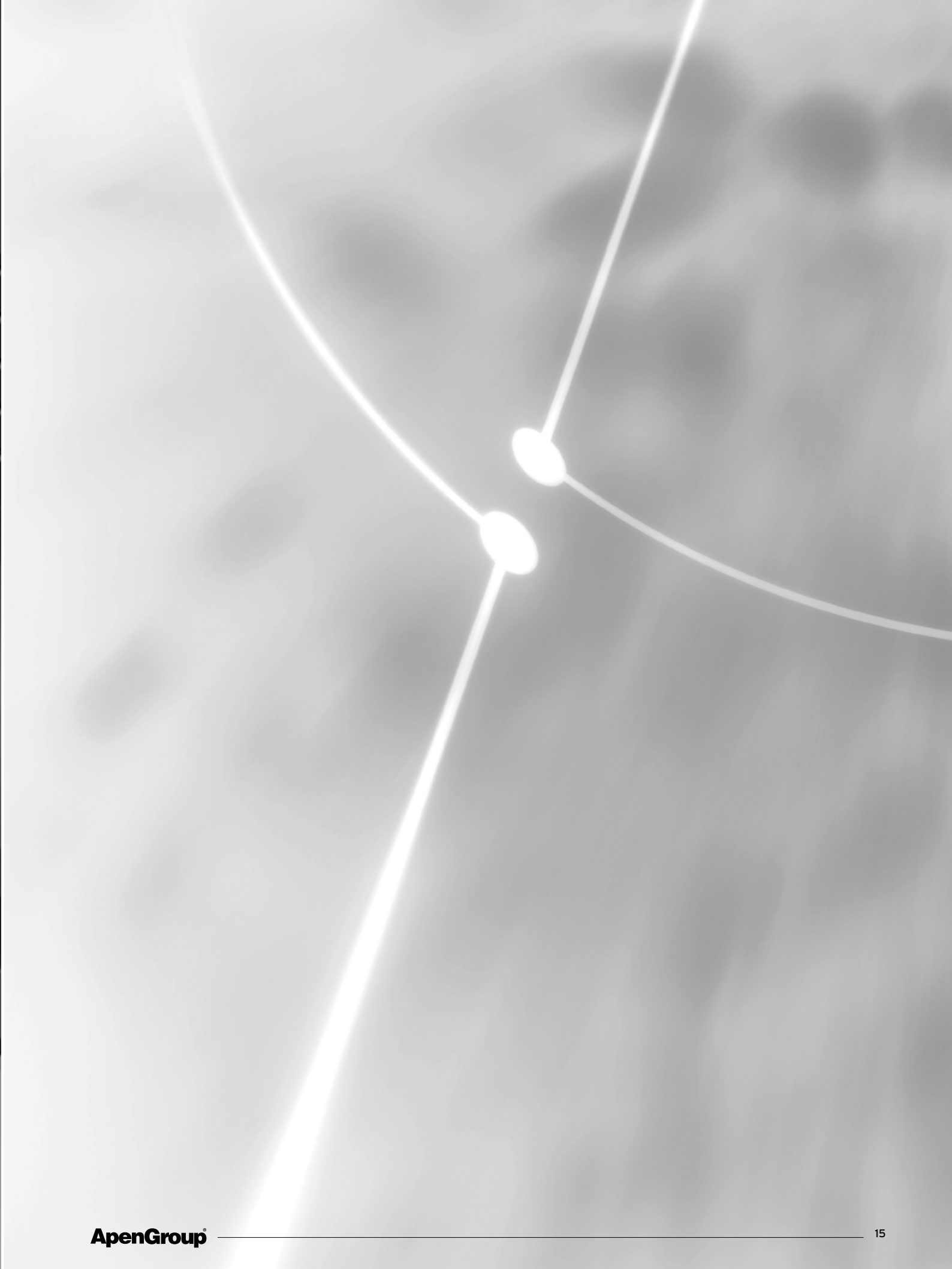

# ApenGroup



## **ApenGroup<sup>®</sup>**

APEN GROUP S.p.A.  
20060 Pessano con Bornago (MI) - Italy  
Via Isonzo, 1 (ex Via Provinciale, 85)  
Phone +39-02-95.96.93.1 Fax +39-02-95.74.27.58  
[www.apengroup.com](http://www.apengroup.com)  
[apen@apengroup.com](mailto:apen@apengroup.com)